

Tech Data

Viega ProPress® Dynamic Auto Balancing Valve, Model 2981.7



Description

Viega ProPress Dynamic Automatic Balancing Valve provides an accurately balanced and reliable system for heating and cooling. Unlike most automatic valves, the Viega valve is an externally

adjustable dynamic valve, allowing for changes in the flow rate after initial install. The valve features high accuracy, a max flow rate memory stop, and Viega's Smart Connect® technology for easy identification of unpressed connection during testing.

Features

- Max flow memory stop
- External adjustment for flow rate
- Isolation function
- Built in PT ports
- No minimum pipe length required prior to the valve
- EPDM sealing elements
- ProPress connections
- Smart Connect technology

Ratings

- Temperature Range: 14°F to 250°F
- Max Pressure Differential: 58 psid



This document is subject to updates. For the most current Viega technical literature, please visit www.viega.us.



Viega products are designed to be installed by licensed and trained plumbing and mechanical professionals who are familiar with Viega products and their installation. **Installation by non-professionals may void Viega LLC's warranty.**

Component	Material
Body	DZR Brass CW602N (½" to 1¼"), Ductile Iron (1½" to 2")
Spring	Stainless Steel
Diaphragm	HNBR
Sealing Element	EPDM

Viega ProPress Dynamic Auto Balancing Valve - Model 2981.7

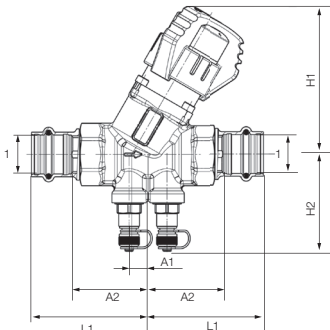

Part No.	Size (in)	H1 (in)	H2 (in)	L1 (in)	A1 (in)	A2 (in)	Flow Range (GPM)	Cv (US gal/min)
	1							
87305	½	3.47	2.32	2.40	0.39	1.58	0.26 - 4.75	3.02
87310	¾	3.47	2.32	2.68	0.39	1.77	0.45 - 8.50	3.02
87315	1	3.58	2.44	2.84	0.39	1.93	0.60 - 10.57	4.87
87320	1¼	4.37	2.76	3.31	0.55	2.28	0.88 - 22.01	12.65
87325	1½	5.20	2.87	4.25	0.83	2.84	3.17 - 32.58	20.88
87330	2	5.20	3.11	4.53	0.83	2.95	3.96 - 45.57	23.55

Operations

The valve can be set to the required position by using the hand wheel to limit the flow rate in certain parts of a system, eliminating overflows and wasted energy.

The internal differential pressure control function of the valve ensures that the set flow rate is limited irrespective of pressure fluctuations in the system.

Once the valve has been pre-set to the desired flow rate, the hand wheel can be locked in position. From this position, the valve can be fully closed for isolation purposes and easily reopened back to the required set point.

Function

The ProPress Dynamic Balancing Valve reacts to pressure fluctuations in a system in order to keep fluctuations to the differential pressure across the unit to a minimum. By achieving this, a maximum flow limit is ensured in accordance with the design.

The following applies:

$$Q = C_v \sqrt{\Delta p}$$

Q = Flow (GPM)

C_v = Opening area

Δp = Differential pressure (psi)

Flow Characteristics

The illustration to the right shows how the flow in the valve reacts in accordance to the pump pressure. For comparison a typical flow characteristic for a static balancing valve is also shown.

The differential pressure function of the valve will work when the differential pressure provided by the pump is sufficient to meet the required minimum differential pressure (which is dependent upon the required flow rate). Once the minimum differential pressure is satisfied, the set flow rate is maintained regardless of any pressure fluctuations in the system.

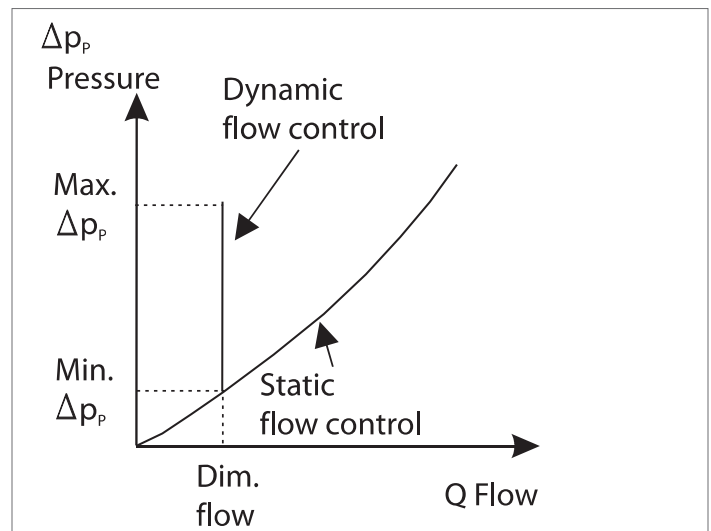
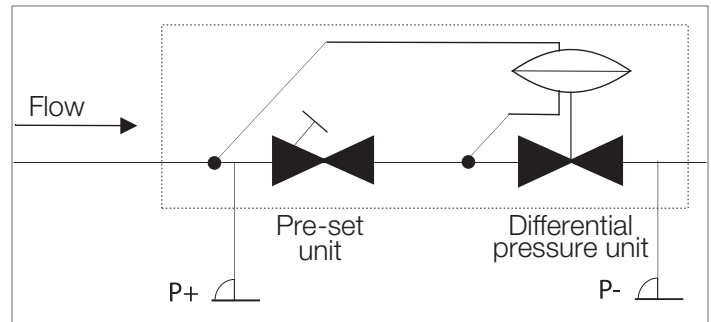

Setting the Valve

The valve is easily set using the pre-setting scale located on the hand wheel. The set point of the valve can be determined by using the flow graphs or tables on the following pages.

The scale on the hand wheel is for the adjustment of flow and is interpreted using the associated setting and flow chart.

Pre-setting desired flow position:

- Set the valve handle to the desired flow
- Remove cap marked Viega, and tighten (turn clockwise) with 2mm hexagonal key
- The valve can then be reopened to the pre-set flow after the valve has been used for isolation

To set the valve to another flow position, loosen the valve pre-setting with the 2mm hexagonal key (turn anti-clockwise) and set the valve handle to the new flow position and tighten.

Isolation

To use the valve for isolation, turn the handle clockwise to the fully closed position. The valve will be closed ensuring leakage tightness according to EN1349 Class IV.

Verification of Dynamic Systems

The flow rate in a system can be verified in two ways:

- Direct flow rate verification in a circuit
- Measurement of the differential pressure across the balancing valve or metering station

Direct Flow Rate Verification

This can, for example, be carried out by ultrasonic equipment. On the basis of the measured velocity of the flow and the pipe dimension the software will compute a flow rate. The use of ultrasonic verification requires free access to the pipes as the sensors are fitted directly to the pipe.



Measurement of the Differential Pressure

This is the main method of flow verification.

Once the design flow rate is known, the valve can be set using the flow graphs. Either of these tools will show the required set point and the required minimum differential pressure for the set flow rate.

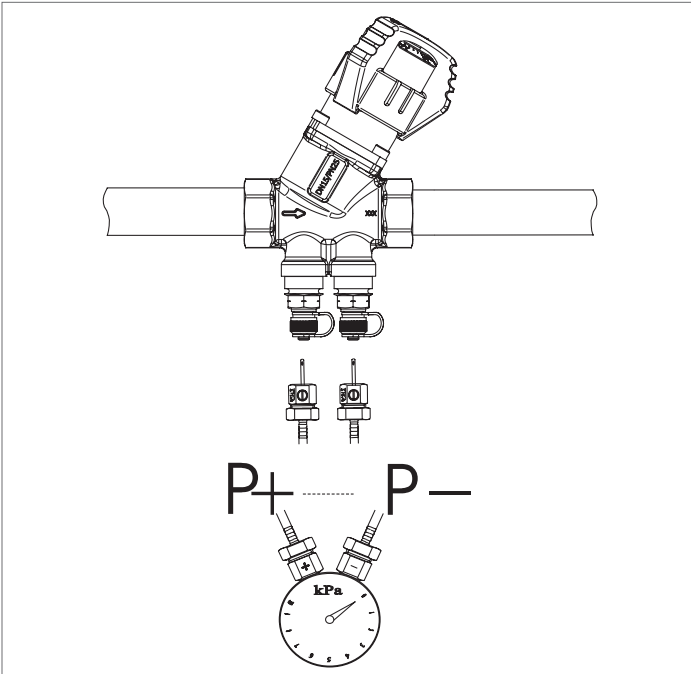

Measurement of the differential pressure (Δp) across the valve

Once the differential pressure has been verified, the flow rate can be recorded according to the flow rate graphs provided.

If the measured differential pressure is below the minimum Δp required for that set point, the flow can be found by using the formulas below.

Flow Calculations

$Q = C_v \cdot \sqrt{\Delta p}$	$Q = \text{gallons/minutes}$ $\Delta p = \text{psi}$
---------------------------------	---

Flow Rate Example 1/2" High

Required design flow rate 600 l/h - 0,167 l/s

1. The required design flow rate is used as the point of reference for the overall rating of dynamic systems. (See the graph to right)
2. The pre-setting for the valve can be determined using the flow rate graph. Setting = 2.2
3. On the right axis, the minimum differential pressure required from the pump can be determined. Minimum DP required approximately 2.10 psi..

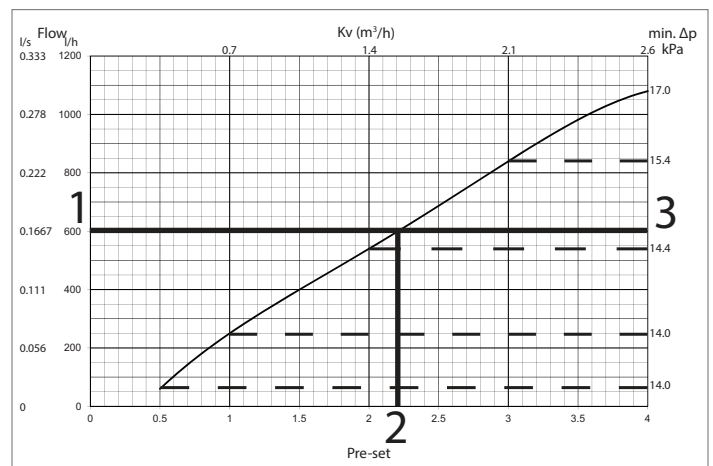

ProPress Dynamic Balancing Valve 1/2" Low

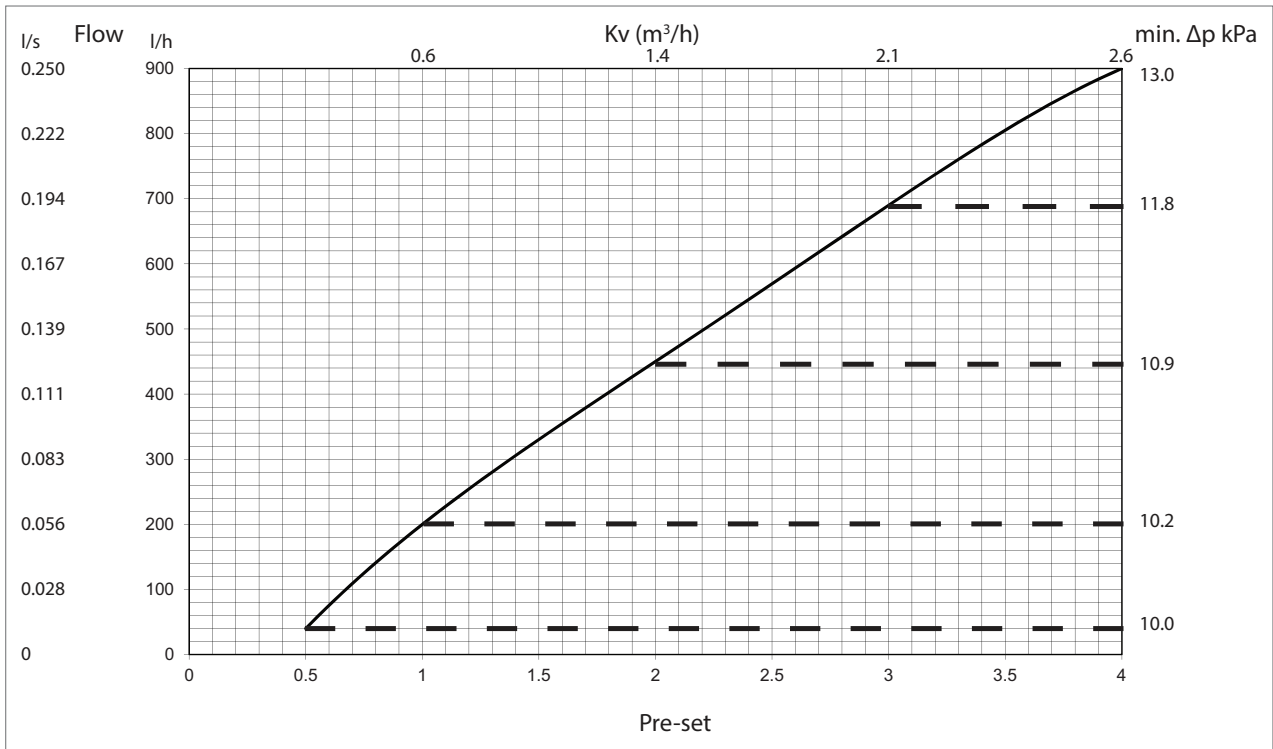

ProPress Dynamic Balancing Valve 1/2" High

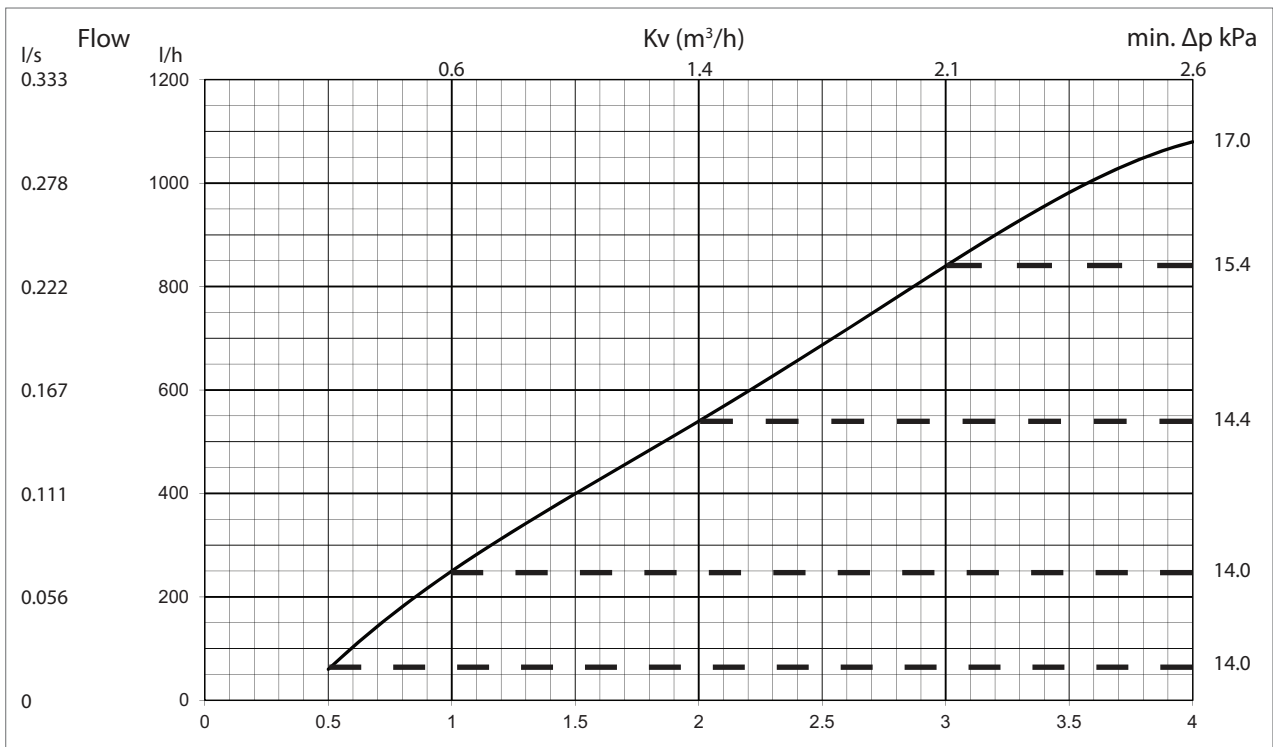

ProPress Dynamic Balancing Valve 3/4" Low

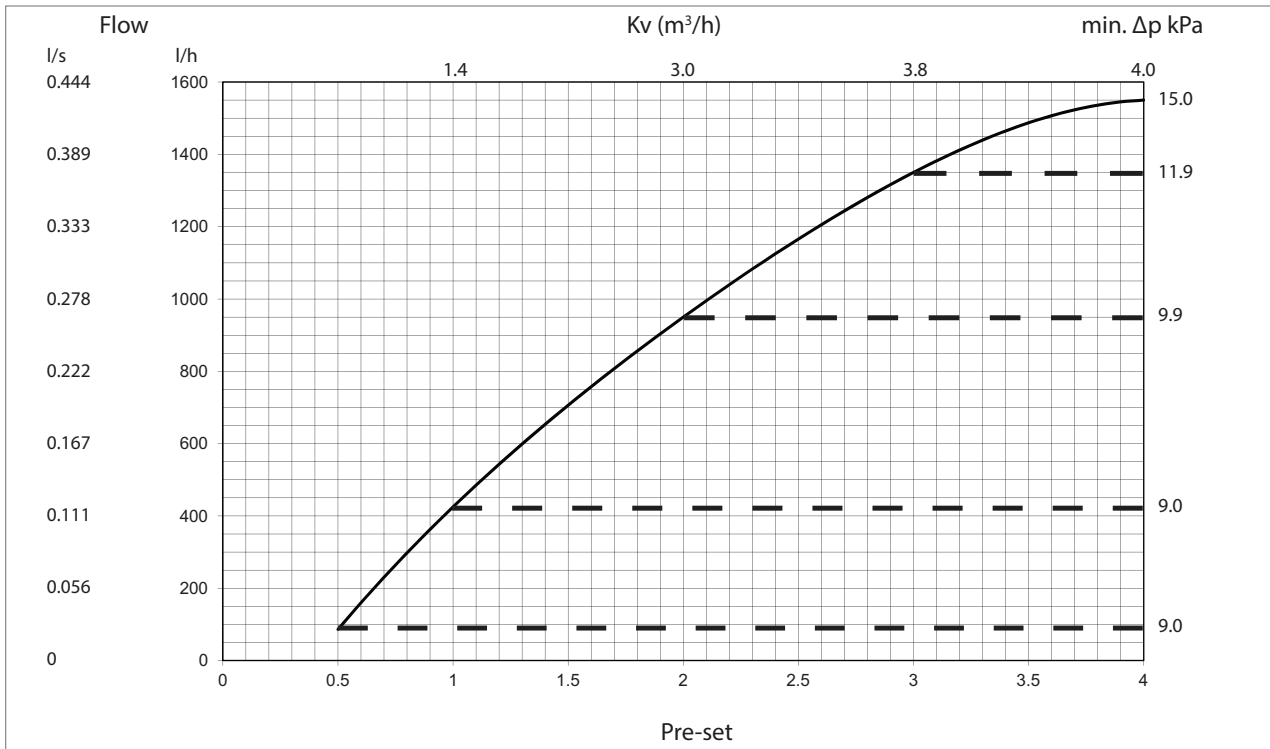

ProPress Dynamic Balancing Valve 3/4" High

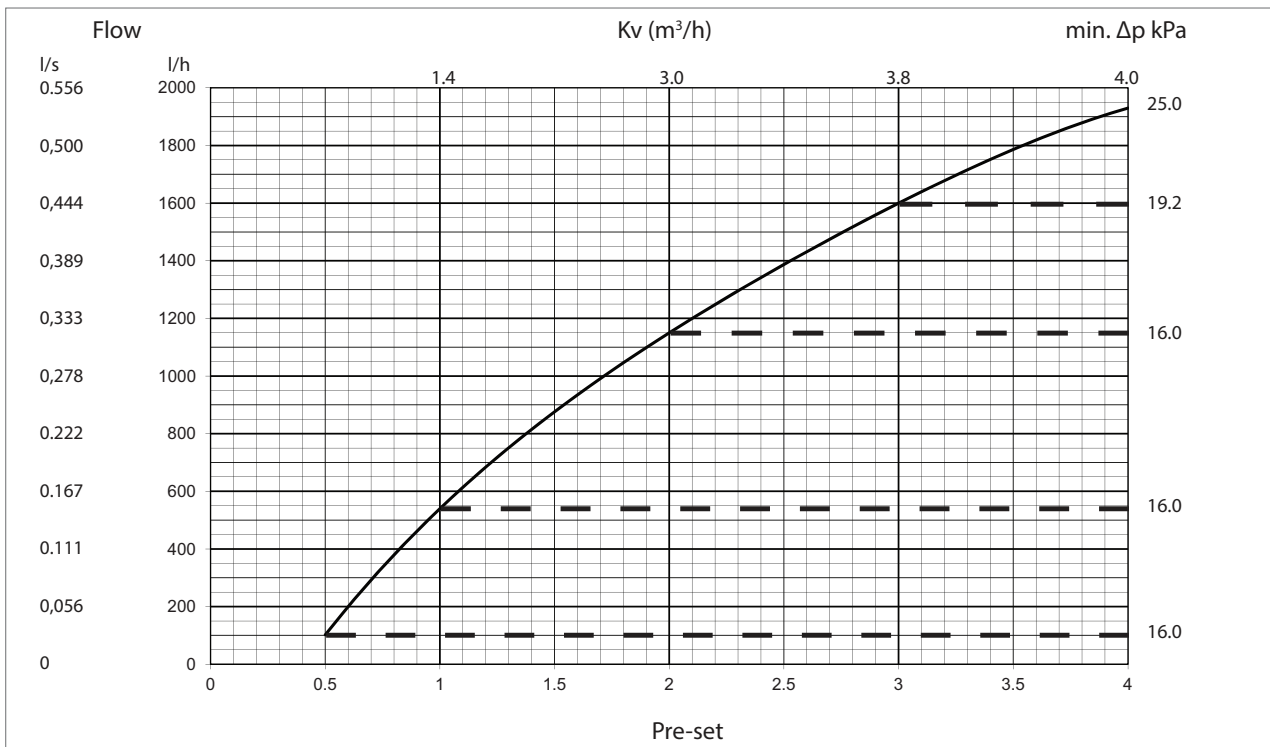

ProPress Dynamic Balancing Valve 1" Low

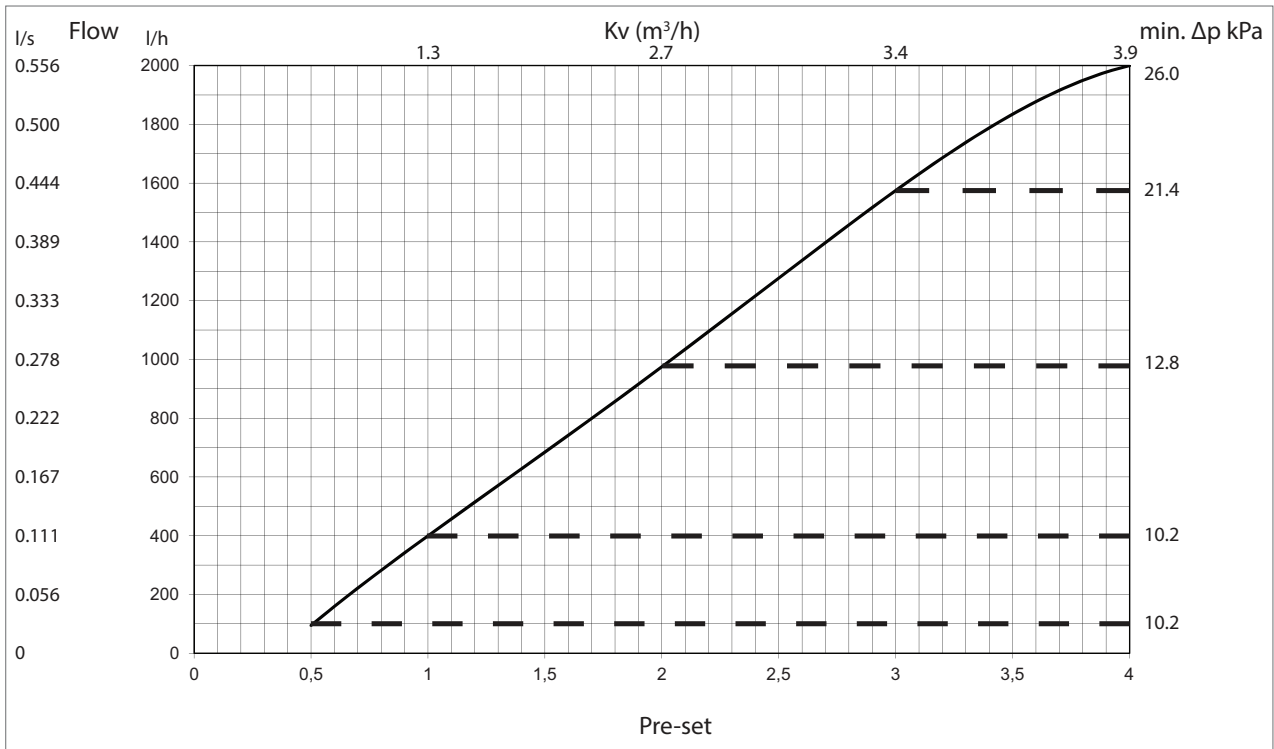

ProPress Dynamic Balancing Valve 1" High

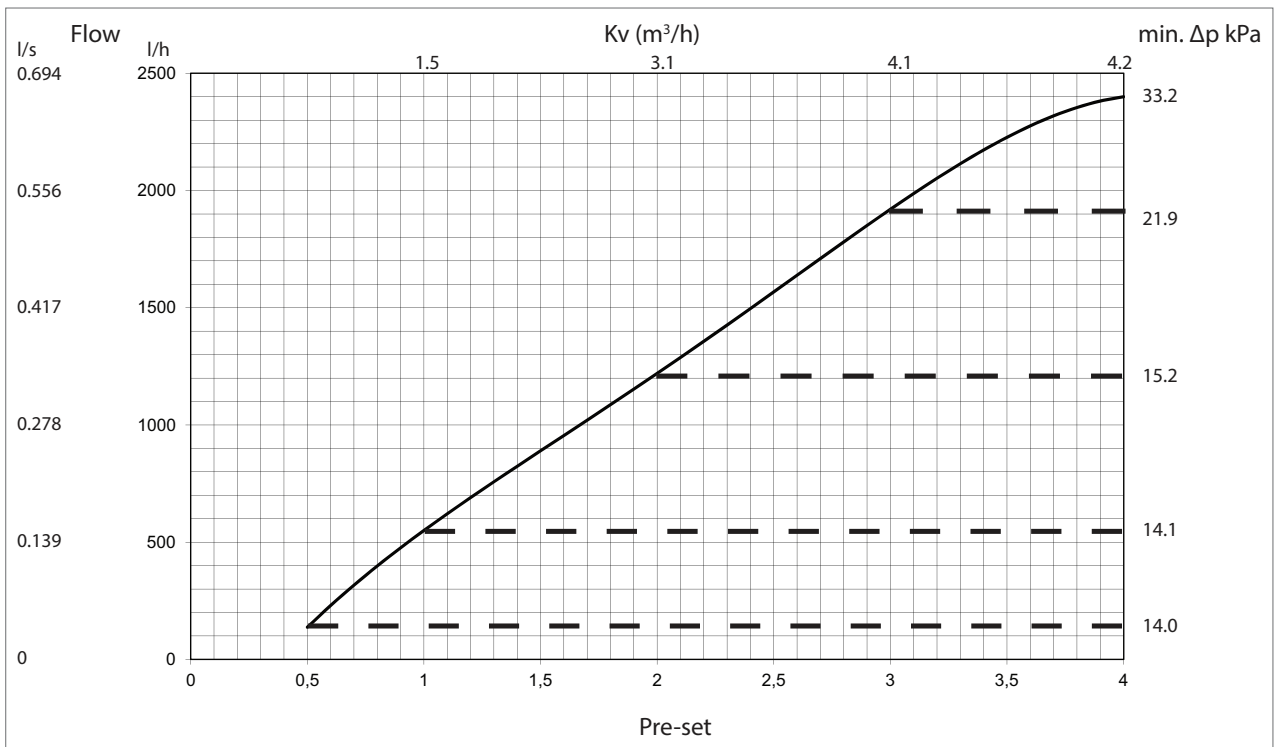

ProPress Dynamic Balancing Valve 1¼"

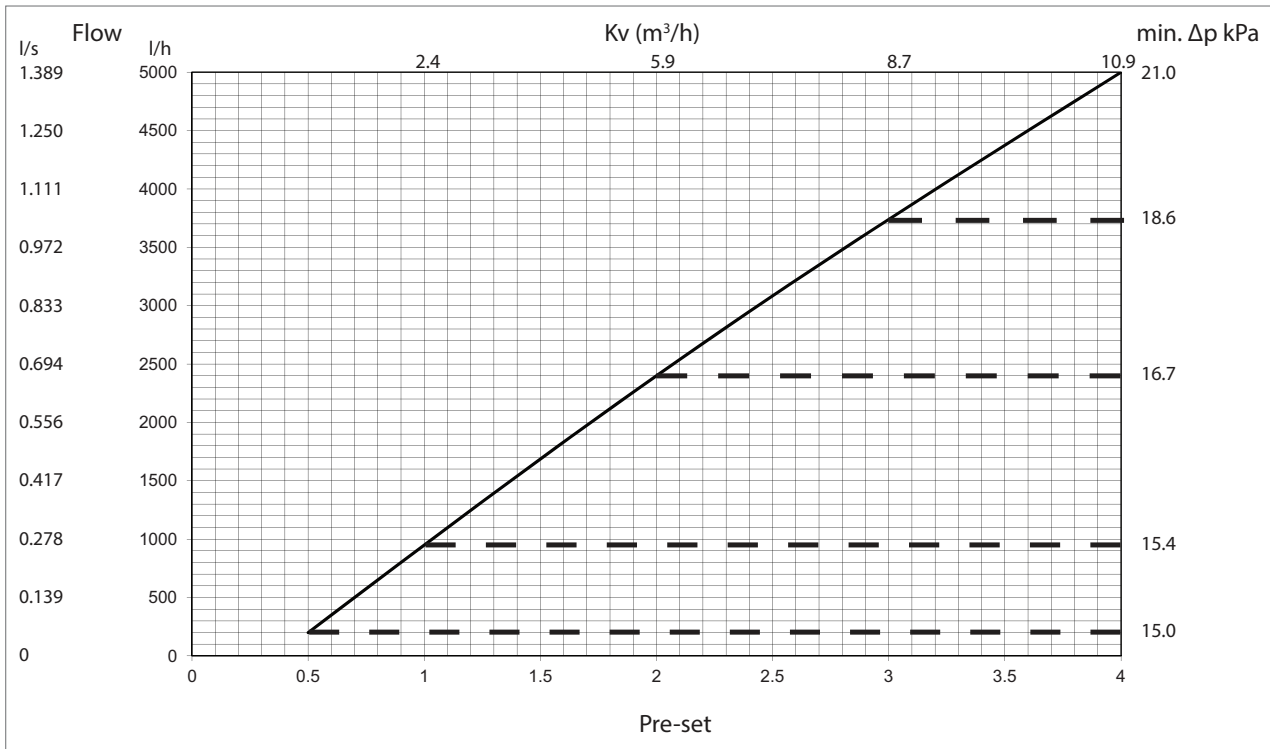

ProPress Dynamic Balancing Valve 1½"

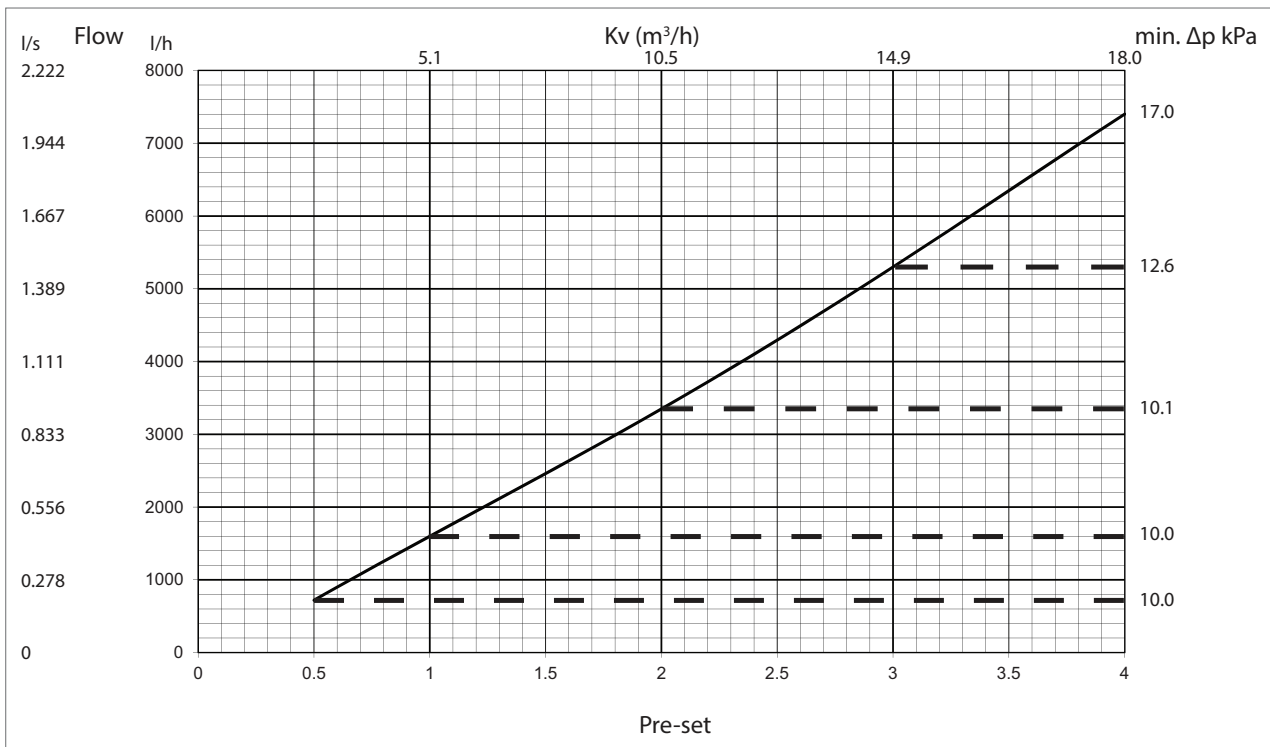

ProPress Dynamic Balancing Valve 2"

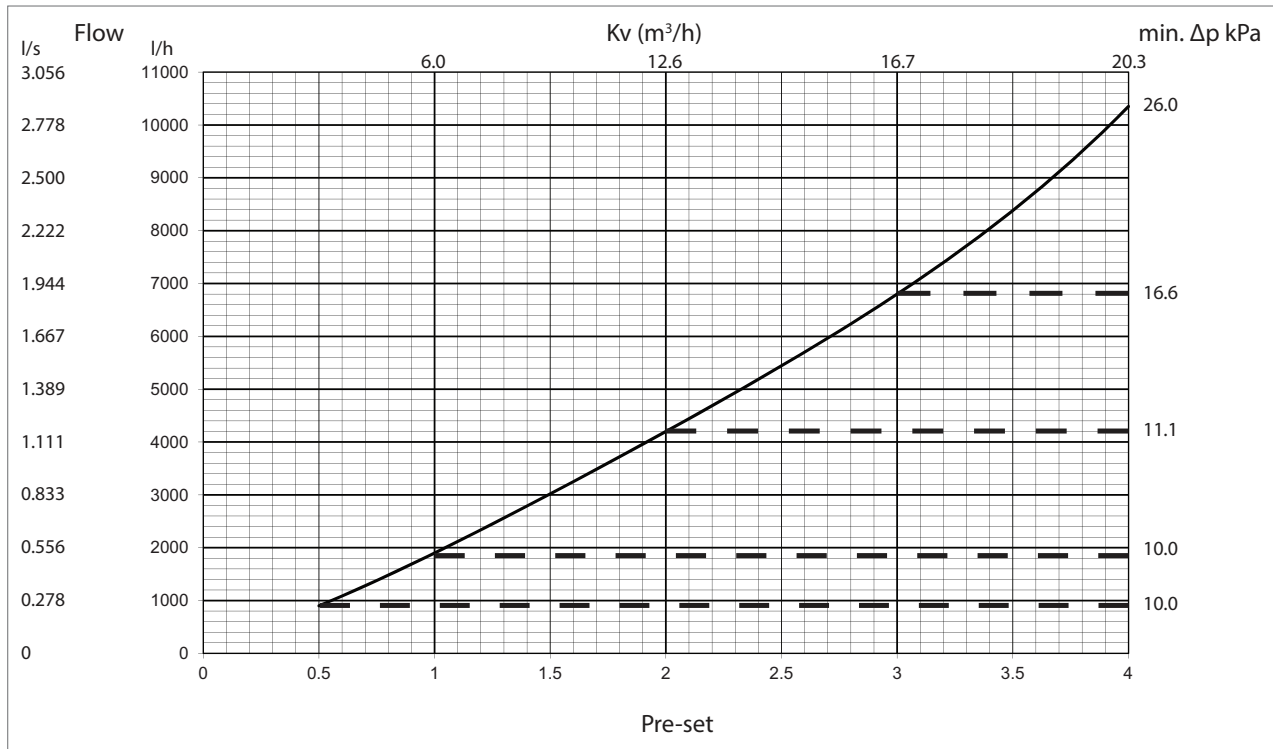

Setting and Flow

Pres-Set	½" Flow (gpm)	¾" Flow (gpm)	1" Flow (gpm)	1¼" Flow (gpm)	1½" Flow (gpm)	2" Flow (gpm)
0.5	0.26	0.45	0.60	0.88	3.17	3.96
0.6	0.45	0.88	1.01	1.54	3.96	4.78
0.7	0.63	1.29	1.36	2.20	4.75	5.63
0.8	0.81	1.67	1.75	2.86	5.52	6.52
0.9	0.95	2.03	2.10	3.52	6.28	7.43
1.0	1.10	2.38	2.42	4.18	7.04	8.37
1.1	1.24	2.70	2.73	4.84	7.80	9.32
1.2	1.38	3.01	3.04	5.49	8.56	10.29
1.3	1.51	3.31	3.34	6.14	9.31	11.28
1.4	1.63	3.59	3.63	6.79	10.07	12.28
1.5	1.76	3.86	3.92	7.43	10.83	13.29
1.6	1.88	4.12	4.20	8.06	11.60	14.31
1.7	2.01	4.36	4.49	8.70	12.38	15.34
1.8	2.13	4.61	4.78	9.33	13.16	16.38
1.9	2.25	4.84	5.08	9.95	13.95	17.43
2.0	2.38	5.06	5.37	10.57	14.75	18.49
2.1	2.50	5.28	5.67	11.18	15.56	19.56
2.2	2.63	5.50	5.97	11.79	16.38	20.64
2.3	2.76	5.70	6.28	12.39	17.21	21.73
2.4	2.89	5.91	6.59	12.99	18.06	22.84
2.5	3.02	6.11	6.90	13.58	18.91	23.96
2.6	3.16	6.30	7.21	14.17	19.77	25.10
2.7	3.29	6.49	7.53	14.75	20.65	26.27
2.8	3.43	6.68	7.84	15.32	21.54	27.46
2.9	3.56	6.87	8.15	15.90	22.43	26.68
3.0	3.70	7.04	8.45	16.47	23.33	29.94
3.1	3.83	7.22	8.75	17.03	24.25	31.23
3.2	3.96	7.39	9.04	17.59	25.17	32.57
3.3	4.09	7.55	9.31	18.15	26.09	33.96
3.4	4.21	7.71	9.57	18.71	27.02	35.40
3.5	4.32	7.86	9.80	19.26	27.95	36.90
3.6	4.43	8.01	10.02	19.81	28.88	38.47
3.7	4.53	8.15	10.21	20.36	29.81	40.12
3.8	4.62	8.27	10.36	20.91	30.74	41.84
3.9	4.69	8.39	10.49	21.46	31.66	43.66
4.0	4.75	8.50	10.57	22.01	32.58	45.57